

4 Part Names of the Remote Control

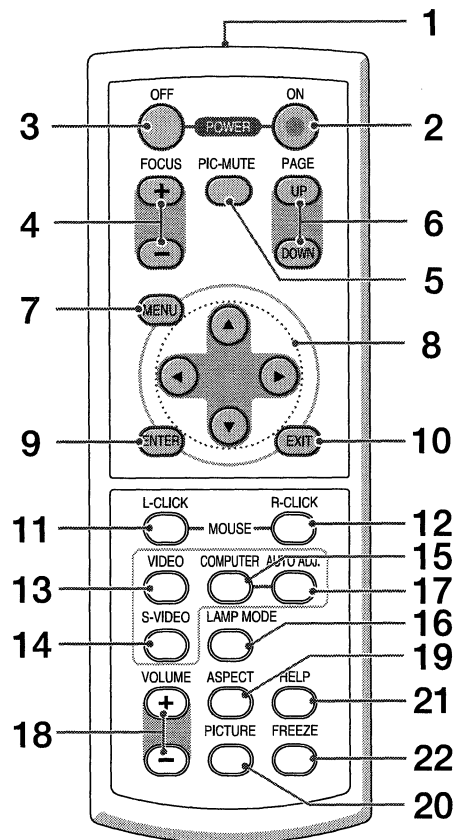

- | | |
|---|---------------------------------------|
| 1. Infrared Transmitter (→ page 8) | 12. R-CLICK MOUSE Button* (→ page 31) |
| 2. POWER ON Button (→ page 17) | 13. VIDEO Button (→ page 19) |
| 3. POWER OFF Button (→ page 27) | 14. S-VIDEO Button (→ page 19) |
| 4. FOCUS (+) (-) Button (→ page 24) | 15. COMPUTER Button (→ page 19) |
| 5. PIC-MUTE Button (→ page 28) | 16. LAMP MODE Button (→ page 28) |
| 6. PAGE (UP) / (DOWN) Button* (→ page 31) | 17. AUTO ADJ. Button (→ page 26) |
| 7. MENU Button | 18. VOLUME (+) (-) Button (→ page 26) |
| 8. SELECT Buttons | 19. ASPECT Button (→ page 38) |
| 9. ENTER Button | 20. PICTURE Button (→ page 37, 38) |
| 10. EXIT Button | 21. HELP Button (→ page 44) |
| 11. L-CLICK MOUSE Button* (→ page 31) | 22. FREEZE Button (→ page 28) |

* Available only when the optional remote mouse receiver is connected with your computer.

Battery Installation

1 Press firmly and slide the battery cover off.

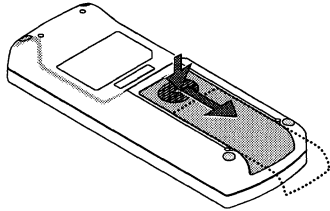

2 Install new batteries (AAA). Ensure that you have the batteries' polarity (+/-) aligned correctly.

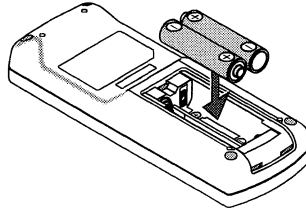

3 Slip the cover back over the batteries until it snaps into place. Do not mix different types of batteries or new and old batteries.

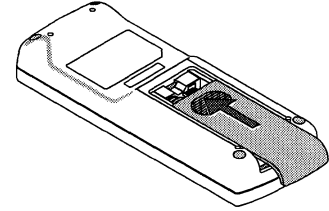

Remote Control Precautions

- Handle the remote control carefully.
- If the remote control gets wet, wipe it dry immediately.
- Avoid excessive heat and humidity.
- Do not heat, take apart, or throw batteries into fire.
- If you will not be using the remote control for a long time, remove the batteries.
- Ensure that you have the batteries' polarity (+/-) aligned correctly.
- Do not use new and old batteries together, or use different types of batteries together.
- Dispose of used batteries according to your local regulations.

Operating Range for Wireless Remote Control

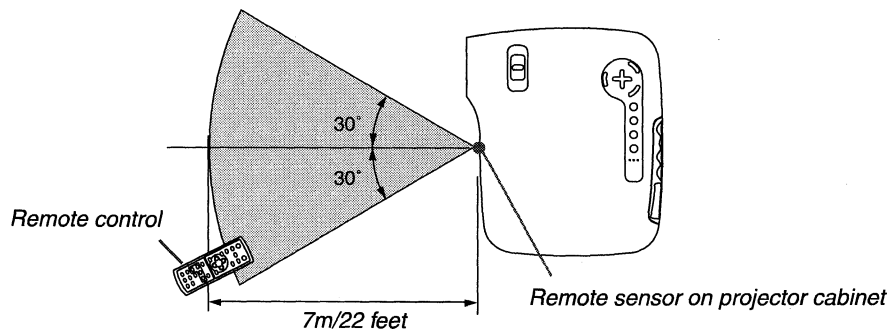

- The infrared signal operates by line-of-sight up to a distance of about 22 feet/7 m and within a 60-degree angle of the remote sensor on the projector cabinet.
- The projector will not respond if there are objects between the remote control and the sensor, or if strong light falls on the sensor. Weak batteries will also prevent the remote control from properly operating the projector.

5 Using the Optional Remote Mouse Receiver

The optional remote mouse receiver enables you to operate your computer's mouse functions from the remote control. It is a great convenience for clicking through your computer-generated presentations.

Connecting the remote mouse receiver to your computer

If you wish to use the remote mouse function, connect the mouse receiver and computer. The mouse receiver can be connected directly to the computer's USB port (type A).

NOTE: Depending on the type of connection or OS installed on your computer, you may have to restart your computer or change your computer settings.

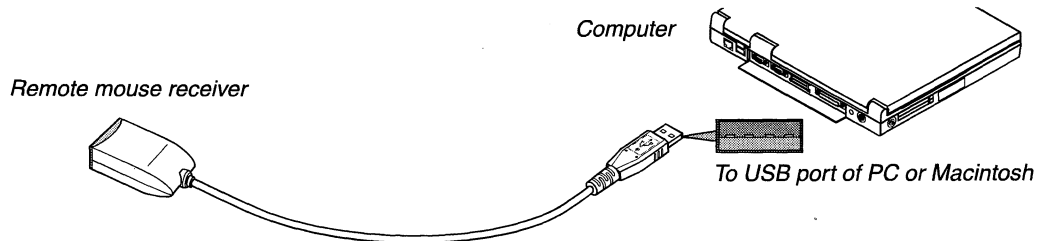

When operating a computer via the remote mouse receiver

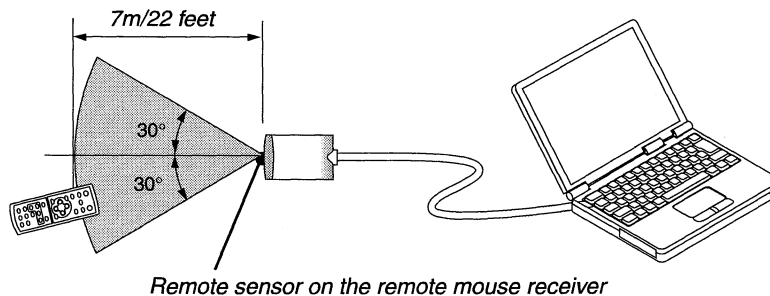

When connecting using the USB terminal

For PC, the mouse receiver can only be used with a Windows 98/Me/XP*, Windows 2000 or Mac OS X 10.0.0 or later operating system.

** NOTE: In Windows XP, if the mouse cursor will not move correctly, do the following: Clear the Enhance pointer precision check box underneath the mouse speed slider in the Mouse Properties dialog box [Pointer Options tab].*

NOTE: Wait at least 5 seconds after disconnecting the mouse receiver before reconnecting it and vice versa. The computer may not identify the mouse receiver if it is repeatedly connected and disconnected in rapid intervals.

Operating your computer's mouse from the remote control

You can operate your computer's mouse from the remote control.

PAGE UP/DOWN Button scrolls the viewing area of the window or to move to the previous or next slide in PowerPoint on your computer.

SELECT ▲▼◀▶ Buttons .. moves the mouse cursor on your computer.

MOUSE L-CLICK Button works as the mouse left button.

MOUSE R-CLICK Button works as the mouse right button.

NOTE: When you operate the computer using the SELECT ▲▼◀ or ▶ button with the menu displayed, both the menu and the mouse pointer will be affected. Close the menu and perform the mouse operation.

TIP: You can change the Pointer speed on the Mouse Properties dialog box on the Windows. For more information, see the user documentation or online help supplied with your computer.